

GOODWAY®

SPECIALTY DRY STEAM TOOLS





9385-SMOOTH: 33' Dry Steam Hose/Gun Assembly for GVC-18000 (Before 2019) with Easy-Clean Smooth Casing **\$1,950.00**
9385-SMOOTH-66: 66' Dry Steam Hose/Gun Assembly for GVC-18000 (Before 2019) with Easy-Clean Smooth Casing **\$2,950.00**
9386-SMOOTH: 33' Dry Steam Hose/Gun Assembly for GVC-18000 & GVC-36000 with Easy-Clean Smooth Casing **\$1,950.00**
9386-SMOOTH-66: 66' Dry Steam Hose/Gun Assembly for GVC-18000 & GVC-36000 with Easy-Clean Smooth Casing **\$2,950.00**



93-KIT0225/XX: Pipe Cleaning Tool - specify pipe OD when ordering..... **\$135-\$245**



93-KIT0933/DR: 50" Extension for Overhead Pipe Attachments..... **\$425.00**



93-KIT0914/ARVE: Short Fan Spray Wand **\$420.00**



93-KIT0915/ARVE: 40" Fan Spray Wand..... **\$535.00**



93-KIT0916/ARVE: 20" Fan Spray Wand..... **\$505.00**













93-KIT0931: Flat Nozzle Short Wand..... **\$145.00**



93-KIT0915/AR35-90: 40" Wand with 90 Degree Spray Nozzle **\$185.00**
93-KIT0915/AR55-90: 40" Wand with 90 Degree Spray Nozzle **\$185.00**



93-KIT0916/AR35-90: 20" Wand with 90 Degree Spray Nozzle **\$145.00**
93-KIT0916/AR55-90: 20" Wand with 90 Degree Spray Nozzle **\$145.00**

	<p>93-ACC-TENTWND: 36" Tent Wand 1/4NPT.....\$995.00</p>
	<p>93-KIT0930: Squeegee Tool Available in 10" or 20".....\$165.00</p>
	<p>93-KIT0930/FDA: Squeegee Tool with FDA Approved Squeegee - 10"\$425.00</p>
	<p>93-KIT0930-EXT: 20" Extension Wand for KIT0930 Squeegee\$155.00</p>
	<p>93-KIT0932/450: Multi-Brush Tool with 20" Wand\$285.00</p>
	<p>93-KIT0932/950: Multi-Brush Tool with 40" wand\$305.00</p>
	<p>93-KIT0934: Floor Spinner Tool with Vacuum Extraction Port. Available in 12" diameter.\$2,495.00</p>
	<p>93-KIT0934-SQG: Floor spinner with squeegee FDA Image attached.\$2,695.00</p>
	<p>93-KIT0934/1: 6.7" Handheld Spinner.....\$1,995.00</p>
	<p>93-KIT0933: 50" Extension for Floor Spinner, Lances, Steam Mops, Squeegee\$395.00</p>
	<p>93-KIT0935/36: Drain Sanitation Tool 14" - Good for circular drains up to 14 inches\$1,395.00</p>



93-KIT0936: 20" Long Stainless Steel Scraper Tool with 2 1/2" scraper for the GVC-18000 **\$345.00**
93-KIT0936-36: 20" Long Stainless Steel Scraper Tool with 2 1/2" scraper for the GVC-36000..... **\$345.00**



93-KIT0936/90: 38" Long Scraper Tool with 3.5" Scraper for the GVC-18000 **\$385.00**
93-KIT0936/90-36: 48" Long Scraper Tool with 3.5" Scraper for the GVC-36000 **\$385.00**



93-KIT0936/O: 20" Brass Scraper Tool 2.5" wide for GVC-18000 **\$345.00**
93-KIT0936/O2: 20" Brass Scraper Tool 2.5" wide for GVC-36000 **\$345.00**



93-KIT0936/X: FDA approved plastic scraper tool for food contact surfaces. Colors available: Blue, Green, Red, Yellow, White. For the GVC-18000 **\$345.00**
93-KIT0936/X2: FDA approved plastic scraper tool for food contact surfaces. Colors available: Blue, Green, Red, Yellow, White. For the GVC-36000 **\$345.00**



93-KIT0026/X: FDA plastic scraper spare blade 2.5". Colors available: Blue, Green, Red, Yellow, White **\$125.00**



93-KIT0939: Barrel Sanitation Tool with Temperature Readout **\$725.00**



93-KIT0942: Angled extension wand for cleaning under machinery with GVC-18000. **\$565.00**
93-KIT0942/5: Angled extension wand for cleaning under machinery with GVC-36000..... **\$565.00**



93-KIT0943: 12" flexible steam wand for GVC-18000 **\$275.00**
93-KIT0943/5: 12" Flexible Steam Wand for GVC-36000..... **\$275.00**



93-KIT0071/X: Holster for Steam Wand/Gun **\$175.00**



93-KIT3000: Accessory Storage Bucket with Bracket **\$595.00**



93-MAP0489/XL: Wide Hook for 66' Hose and Extension Cords..... **\$305.00**



93-KIT0715/QR: 24" Steam Mop **\$285.00**



93-KITQ704: 24" Microfiber Cloth for 93-KIT0715 **\$85.00**



93-KIT0714/QR: 16" Steam Mop..... **\$245.00**



93-KITQ706: 16" Microfiber Cloth for 93-KIT0714 **\$82.00**



93-STEAM-CANNON-450MM: Dry Steam Cannon Attachment **\$975.00**



93-BRUSH-FDA-LG: Large Color Coded Nylon Scrub - FDA Approved Bristles, Stainless Steel Staples. Colors Available: White, Yellow, Red, Green, Blue..... **\$14.00**



93-BRUSH-FDA-MD: Medium Color Coded Nylon Scrub - FDA Approved Bristles, Stainless Steel Staples. Colors Available: White, Yellow, Red, Green, Blue **\$12.00**



93-BRUSH-FDA-SM: Small Brush - Color Coded Nylon Scrub - FDA Approved Bristles, Stainless Steel Staples. Colors Available: White, Yellow, Red, Green, Blue **\$10.00**



9319-VAC-KIT | 9319-VAC-KIT-8: Dry Steam/vacuum kit including small vacuum, mounting bracket, steam/vacuum hose and full set of tools. Ideal for steam cleaning floors, walls and other flat areas while simultaneously vacuuming away soils and moisture.....**\$2,795.00**



9387: Dry Steam/Vacuum Hose 18 feet**\$1,095.00**



9387-60: Dry Steam/Vacuum Hose 60 feet (requires stronger vacuum - EV-60-T or AV-1200)**\$2,495.00**



93-KIT0808/AD: Adapter connects 93-ACC-FT200 to 9387 steam hose..... **\$45.00**



93-KIT0805/M: 12" Squeegee **\$85.00**



93-KIT0806/M: 4" Clear Squeegee **\$68.00**



93-KIT0801: Extension Tube **\$115.00**



93-KIT0802: Short Extension Tube **\$50.00**



93-KIT0810: Angled Extension **\$45.00**



93-KIT0803: 20" Floor Brush with 93-KIT0825 Squeegee **\$155.00**



93-KIT0804: 12" Floor Brush with 93-KIT0823 Squeegee **\$135.00**



93-HWE-CORD-6-4-25: 25' Power Cord for GVC-36000 and GVC-18000-230V **\$350.00**

93-HWE-CORD-6-4-50: 50' Power Cord for GVC-36000 and GVC-18000-230V **\$700.00**

93-HWE-CORD-6-4-75: 75' Power Cord for GVC-36000 and GVC-18000-230V **\$1,050.00**

93-HWE-CORD-6-4-100: 100' Power Cord for GVC-36000 and GVC-18000-230V **\$1,400.00**

93-HWE-CORD-10-4-25: 25' Power Cord for GVC-18000 **\$185.00**

93-HWE-CORD-10-4-50: 50' Power Cord for GVC-18000 **\$370.00**

93-HWE-CORD-10-4-75: 75' Power Cord for GVC-18000 **\$555.00**

93-HWE-CORD-10-4-100: 100' Power Cord for GVC-18000 **\$1,400.00**

PUREBELT® MODULAR SYSTEM - CONVEYOR BELT CLEANING SYSTEM FOR INTRALOX MESH AND METAL WIRE BELTS



PUREBELT® MODULAR SYSTEM: Is a robotic automated conveyor belt cleaning system. For mesh belts. Standard version is 45", wider versions available..... **Call for Price**



GVC-SH-25-10-ASSM: 10' Steam Hose with 1/4" Inside Diameter
Connects Dry Steam Cleaner to Belt Cleaning System **\$1,595.00**

GVC-SH-25-20-ASSM: 20' Steam Hose with 1/4" Inside Diameter
Connects Dry Steam Cleaner to Belt Cleaning System **\$2,395.00**

GVC-SH-25-30-ASSM: 30' Steam Hose with 1/4" Inside Diameter
Connects Dry Steam Cleaner to Belt Cleaning System **\$3,695.00**

GVC-SH-38-10-ASSM: 10' Steam Hose with 3/8" Inside Diameter
Connects Dry Steam Cleaner to Belt Cleaning System **\$1,595.00**

GVC-SH-38-20-ASSM: 20' Steam Hose with 3/8" Inside Diameter
Connects Dry Steam Cleaner to Belt Cleaning System **\$2,395.00**

GVC-SH-38-30-ASSM: 30' Steam Hose with 3/8" Inside Diameter
Connects Dry Steam Cleaner to Belt Cleaning System **\$3,695.00**



93-KIT5003/8: Adapter connects GVC to 93-ACC-SH..... **\$395.00**

93-KIT5003/8-NEW: Adapter connects GVC to 93-ACC-SH,
large diameter..... **\$395.00**



93-KIT5003/8RC2: Remote control adapter, Belt Cleaner to GVC-18000, 1/4 x 8MM + 12V Connectors M+F..... **Call for Price**

93-KIT5003/8RC1: Remote control adapter, Belt Cleaner to GVC-36000, 3/8 x 8MM + 12V Connectors M+F..... **Call for Price**



GVC-MODULAR-PWRCORD: 3 meter power cord for GVC-MODULAR..... **\$305.00**

PORTABLE BRUSHLESS/BRUSH SYSTEMS: CONVEYOR BELT CLEANING SYSTEM FOR FLAT, SOLID (WEB) BELTS



PUREBELT® PORTABLE BRUSHLESS BELT CLEANING SYSTEM: for Flat Belt Systems with dry steam and vacuum. Completely portable..... **Call for Price**

PUREBELT® PORTABLE BRUSH SYSTEM: CIP System for Flat, Solid Belts with dry steam and vacuum. Completely portable and will fit a range of belt widths up to 10" with an additional motorized food grade brush..... **Call for Price**



GVC-SH-25-10-ASSM: 10' Steam Hose with 1/4" Inside Diameter Connects Dry Steam Cleaner to Belt Cleaning System **\$1,595.00**

GVC-SH-25-20-ASSM: 20' Steam Hose with 1/4" Inside Diameter Connects Dry Steam Cleaner to Belt Cleaning System **\$2,395.00**

GVC-SH-25-30-ASSM: 30' Steam Hose with 1/4" Inside Diameter Connects Dry Steam Cleaner to Belt Cleaning System **\$3,695.00**

GVC-SH-38-10-ASSM: 10' Steam Hose with 3/8" Inside Diameter Connects Dry Steam Cleaner to Belt Cleaning System **\$1,595.00**

GVC-SH-38-20-ASSM: 20' Steam Hose with 3/8" Inside Diameter Connects Dry Steam Cleaner to Belt Cleaning System **\$2,395.00**

GVC-SH-38-30-ASSM: 30' Steam Hose with 3/8" Inside Diameter Connects Dry Steam Cleaner to Belt Cleaning System **\$3,695.00**



93-KIT5003/8: Adapter connects GVC to 93-ACC-SH **\$395.00**

93-KIT5003/8-NEW: Adapter connects GVC to 93-ACC-SH, large diameter **\$395.00**



VAC-32-BRUSHLESS Smooth bore PVC Hose for Belt Cleaning **Call for Price**

FIXED BRUSH/BRUSHLESS SYSTEM: CONVEYOR BELT CLEANING SYSTEM FOR FLAT, SOLID (WEB) BELTS



PUREBELT® FIXED BRUSHLESS BELT CLEANING SYSTEM:

Permanent clean-in place of flat belts. Contentiously clean even during production. **Call for Price**



93-KIT5003/8: Adapter connects GVC to 93-ACC-SH..... **\$395.00**

93-KIT5003/8-NEW: Adapter connects GVC to 93-ACC-SH, large diameter..... **\$395.00**



GVC-SH-25-10-ASSM: 10' Steam Hose with 1/4" Inside Diameter Connects Dry Steam Cleaner to Belt Cleaning System **\$1,595.00**

GVC-SH-25-20-ASSM: 20' Steam Hose with 1/4" Inside Diameter Connects Dry Steam Cleaner to Belt Cleaning System **\$2,395.00**

GVC-SH-25-30-ASSM: 30' Steam Hose with 1/4" Inside Diameter Connects Dry Steam Cleaner to Belt Cleaning System **\$3,695.00**

GVC-SH-38-10-ASSM: 10' Steam Hose with 3/8" Inside Diameter Connects Dry Steam Cleaner to Belt Cleaning System **\$1,595.00**

GVC-SH-38-20-ASSM: 20' Steam Hose with 3/8" Inside Diameter Connects Dry Steam Cleaner to Belt Cleaning System **\$2,395.00**

GVC-SH-38-30-ASSM: 30' Steam Hose with 3/8" Inside Diameter Connects Dry Steam Cleaner to Belt Cleaning System **\$3,695.00**



93-KIT5003/8RC2: Remote control adapter, Belt Cleaner to GVC-18000, 1/4 x 8MM + 12V Connectors M+F..... **Call for Price**

93-KIT5003/8RC1: Remote control adapter, Belt Cleaner to GVC-36000, 3/8 x 8MM + 12V Connectors M+F..... **Call for Price**



1-800-333-7467

www.goodway.com

420 West Avenue, Stamford, CT 06902-6384 U.S.A. | 203-359-4708 | Fax: 203-359-9601 | goodway@goodway.com

Goodway is not responsible for typographical errors in product descriptions or pricing. Product availability and features may change. Actual products may differ slightly in appearance to images shown. Please contact Goodway with any questions prior to purchase. © Crossford International All Rights Reserved.

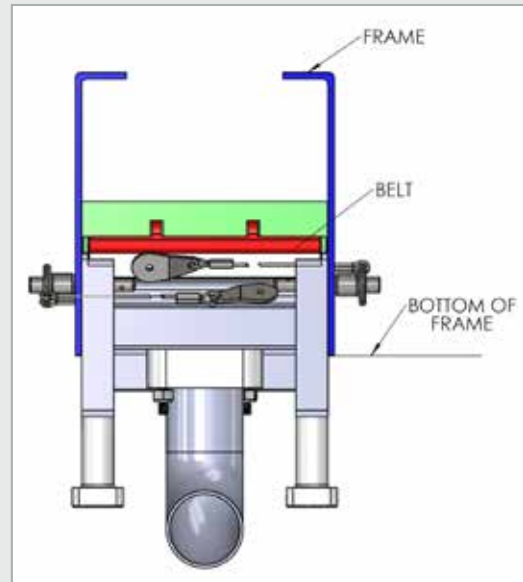

PUREBELT® BOTTLING LINE BELT CLEANING SYSTEM: Belt cleaning system cleans bottling line belts in place automatically with dry steam and vacuum extraction..... **Call for Price**

NARROW WIDTH SUSPENDED BRUSHLESS: For brushless applications with high guide rails, or that need to be suspended in a unique way, we can customize to fit your specific application..... **Call for Price**

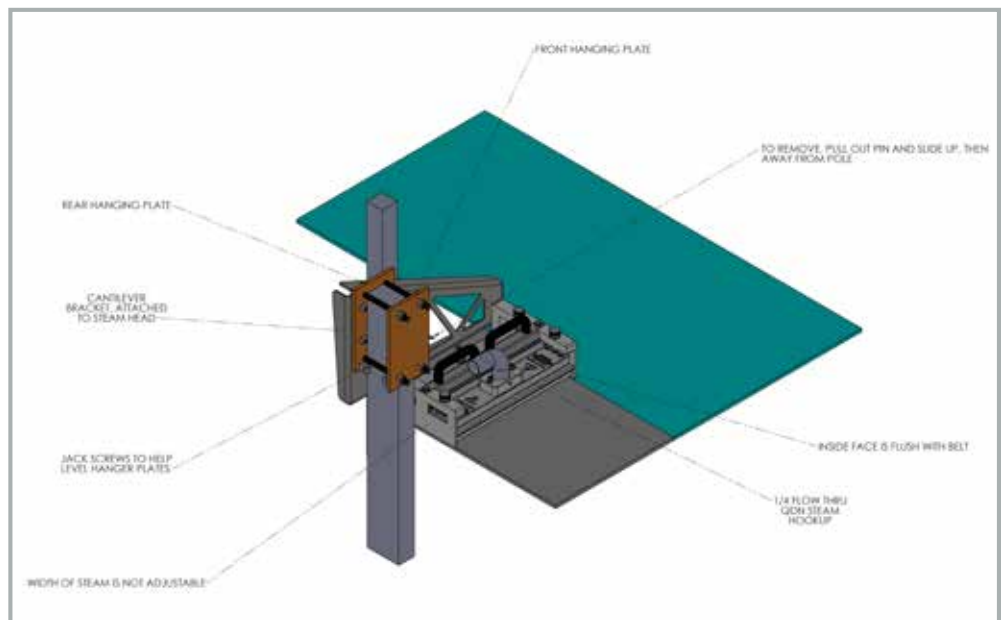

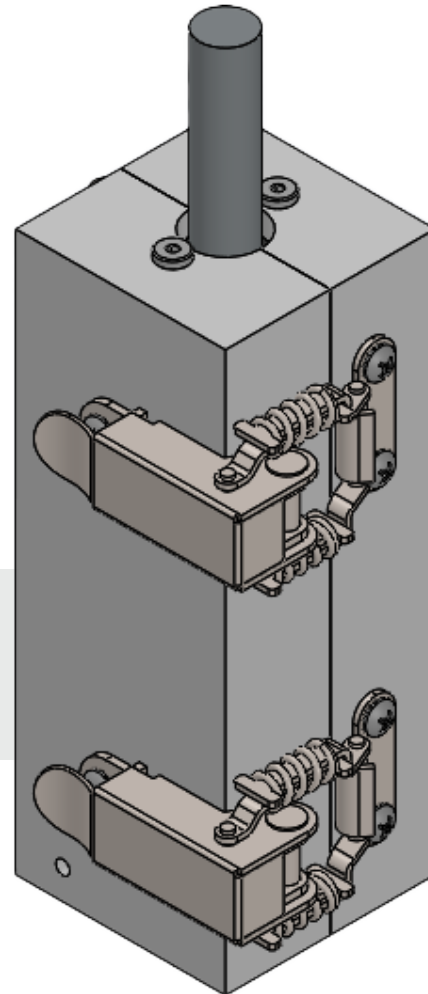

NOZZLE SANITIZING SYSTEM: designed to sanitize filler nozzles and water cutting nozzles from the bottom up by applying steam to sanitize microorganisms **Call for Price**



 1-800-333-7467

 www.goodway.com

420 West Avenue, Stamford, CT 06902-6384 U.S.A. | 203-359-4708 | Fax: 203-359-9601 | goodway@goodway.com

Goodway is not responsible for typographical errors in product descriptions or pricing. Product availability and features may change. Actual products may differ slightly in appearance to images shown. Please contact Goodway with any questions prior to purchase. © Crossford International All Rights Reserved.

CONTINUED CUSTOM AUTOMATED CLEANING SOLUTIONS

BUN PAN CLEANING SYSTEM:

Customizable Pan Width - Designed for Glaze / Egg Wash Removal..... **Call for Price**

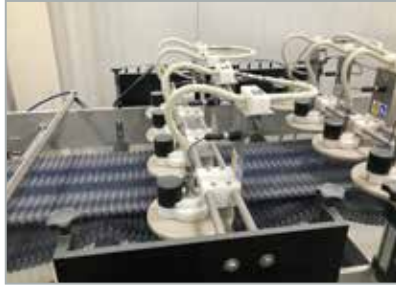

PUREBELT® FLEX:

Stationary spinner with adjustable mount..... **Call for Price**

PORTABLE BRUSHLESS SYSTEM WITHOUT STIFFENER PLATE:

Portable Brushless without the standard stiffener plate. For quicker setup & tight spaces. **Call for Price**



GVC-CART-XXX: Our belt cleaner carts offer secure storage for both our PureBelt® Modular & Portable. The carts feature robust stainless steel construction that is built to last, swivel castors for easy mobility and multiple hooks for storing hoses and accessories. Some models also feature a squeegee replacement station.... **Call for Price**

PUREBELT PORTABLE SHORT: Portable brushless belt cleaner made to fit into tight spaces... .. **Call for Price**

