

GOODWAY®

SPECIALTY DRY STEAM TOOLS





9385-SMOOTH: 33' Dry Steam Hose/Gun Assembly for GVC-18000 (Before 2019) with Easy-Clean Smooth Casing **\$1,950.00**
9385-SMOOTH-66: 66' Dry Steam Hose/Gun Assembly for GVC-18000 (Before 2019) with Easy-Clean Smooth Casing **\$2,950.00**
9386-SMOOTH: 33' Dry Steam Hose/Gun Assembly for GVC-18000 & GVC-36000 with Easy-Clean Smooth Casing **\$1,950.00**
9386-SMOOTH-66: 66' Dry Steam Hose/Gun Assembly for GVC-18000 & GVC-36000 with Easy-Clean Smooth Casing **\$2,950.00**



93-KIT0225/XX: Pipe Cleaning Tool - specify pipe OD when ordering..... **\$135-\$245**



93-KIT0933/DR: 50" Extension for Overhead Pipe Attachments..... **\$425.00**



93-KIT0914/ARVE: Short Fan Spray Wand **\$420.00**



93-KIT0915/ARVE: 40" Fan Spray Wand..... **\$535.00**



93-KIT0916/ARVE: 20" Fan Spray Wand..... **\$505.00**



93-KIT0931: Flat Nozzle Short Wand..... **\$145.00**



93-KIT0915/AR35-90: 40" Wand with 90 Degree Spray Nozzle..... **\$185.00**









93-KIT0915/AR55-90: 40" Wand with 90 Degree Spray Nozzle..... **\$185.00**



93-KIT0916/AR35-90: 20" Wand with 90 Degree Spray Nozzle..... **\$145.00**

93-KIT0916/AR55-90: 20" Wand with 90 Degree Spray Nozzle..... **\$145.00**



	<p>93-ACC-TENTWND: 36" Tent Wand 1/4NPT.....\$995.00</p>
	<p>93-KIT0930: Squeegee Tool Available in 10" or 20".....\$165.00</p>
	<p>93-KIT0930/FDA: Squeegee Tool with FDA Approved Squeegee - 10"\$425.00</p>
	<p>93-KIT0930-EXT: 20" Extension Wand for KIT0930 Squeegee\$155.00</p>
	<p>93-KIT0932/450: Multi-Brush Tool with 20" Wand\$285.00</p>
	<p>93-KIT0932/950: Multi-Brush Tool with 40" wand\$305.00</p>
	<p>93-KIT0934: Floor Spinner Tool with Vacuum Extraction Port. Available in 12" diameter.\$2,495.00</p>
	<p>93-KIT0934-SQG: Floor spinner with squeegee FDA Image attached.\$2,695.00</p>
	<p>93-KIT0934/1: 6.7" Handheld Spinner.....\$1,995.00</p>
	<p>93-KIT0933: 50" Extension for Floor Spinner, Lances, Steam Mops, Squeegee\$395.00</p>
	<p>93-KIT0935/36: Drain Sanitation Tool 14" - Good for circular drains up to 14 inches\$1,395.00</p>



93-KIT0936: 20" Long Stainless Steel Scraper Tool with 2 ½" scraper for the GVC-18000 **\$345.00**
93-KIT0936-36: 20" Long Stainless Steel Scraper Tool with 2 ½" scraper for the GVC-36000..... **\$345.00**



93-KIT0936/90: 38" Long Scraper Tool with 3.5" Scraper for the GVC-18000 **\$385.00**
93-KIT0936/90-36: 48" Long Scraper Tool with 3.5" Scraper for the GVC-36000 **\$385.00**



93-KIT0936/O: 20" Brass Scraper Tool 2.5" wide for GVC-18000 **\$345.00**
93-KIT0936/O2: 20" Brass Scraper Tool 2.5" wide for GVC-36000 **\$345.00**



93-KIT0936/X: FDA approved plastic scraper tool for food contact surfaces. Colors available: Blue, Green, Red, Yellow, White. For the GVC-18000 **\$345.00**
93-KIT0936/X2: FDA approved plastic scraper tool for food contact surfaces. Colors available: Blue, Green, Red, Yellow, White. For the GVC-36000 **\$345.00**



93-KIT0026/X: FDA plastic scraper spare blade 2.5". Colors available: Blue, Green, Red, Yellow, White **\$125.00**



93-KIT0939: Barrel Sanitation Tool with Temperature Readout **\$725.00**



93-KIT0942: Angled extension wand for cleaning under machinery with GVC-18000. **\$565.00**

93-KIT0942/5: Angled extension wand for cleaning under machinery with GVC-36000..... **\$565.00**



93-KIT0943: 12" flexible steam wand for GVC-18000 **\$275.00**

93-KIT0943/5: 12" Flexible Steam Wand for GVC-36000..... **\$275.00**



93-KIT0071/X: Holster for Steam Wand/Gun **\$175.00**



93-KIT3000: Accessory Storage Bucket with Bracket **\$595.00**



93-MAP0489/XL: Wide Hook for 66' Hose and Extension Cords..... **\$305.00**



93-KIT0715/QR: 24" Steam Mop **\$285.00**



93-KITQ704: 24" Microfiber Cloth for 93-KIT0715 **\$85.00**



93-KIT0714/QR: 16" Steam Mop..... **\$245.00**



93-KITQ706: 16" Microfiber Cloth for 93-KIT0714 **\$82.00**



93-STEAM-CANNON-450MM: Dry Steam Cannon Attachment **\$975.00**



93-BRUSH-FDA-LG: Large Color Coded Nylon Scrub - FDA Approved Bristles, Stainless Steel Staples. Colors Available: White, Yellow, Red, Green, Blue..... **\$14.00**



93-BRUSH-FDA-MD: Medium Color Coded Nylon Scrub - FDA Approved Bristles, Stainless Steel Staples. Colors Available: White, Yellow, Red, Green, Blue **\$12.00**



93-BRUSH-FDA-SM: Small Brush - Color Coded Nylon Scrub - FDA Approved Bristles, Stainless Steel Staples. Colors Available: White, Yellow, Red, Green, Blue **\$10.00**



9319-VAC-KIT | 9319-VAC-KIT-8: Dry Steam/vacuum kit including small vacuum, mounting bracket, steam/vacuum hose and full set of tools. Ideal for steam cleaning floors, walls and other flat areas while simultaneously vacuuming away soils and moisture.....**\$2,795.00**



9387: Dry Steam/Vacuum Hose 18 feet**\$1,095.00**



9387-60: Dry Steam/Vacuum Hose 60 feet (requires stronger vacuum - EV-60-T or AV-1200)**\$2,495.00**



93-KIT0808/AD: Adapter connects 93-ACC-FT200 to 9387 steam hose..... **\$45.00**



93-KIT0805/M: 12" Squeegee **\$85.00**



93-KIT0806/M: 4" Clear Squeegee **\$68.00**



93-KIT0801: Extension Tube **\$115.00**



93-KIT0802: Short Extension Tube **\$50.00**



93-KIT0810: Angled Extension **\$45.00**



93-KIT0803: 20" Floor Brush with 93-KIT0825 Squeegee **\$155.00**



93-KIT0804: 12" Floor Brush with 93-KIT0823 Squeegee **\$135.00**



93-HWE-CORD-6-4-25: 25' Power Cord for GVC-36000 and GVC-18000-230V **\$350.00**

93-HWE-CORD-6-4-50: 50' Power Cord for GVC-36000 and GVC-18000-230V **\$700.00**

93-HWE-CORD-6-4-75: 75' Power Cord for GVC-36000 and GVC-18000-230V **\$1,050.00**

93-HWE-CORD-6-4-100: 100' Power Cord for GVC-36000 and GVC-18000-230V **\$1,400.00**

93-HWE-CORD-10-4-25: 25' Power Cord for GVC-18000 **\$185.00**

93-HWE-CORD-10-4-50: 50' Power Cord for GVC-18000 **\$370.00**

93-HWE-CORD-10-4-75: 75' Power Cord for GVC-18000 **\$555.00**

93-HWE-CORD-10-4-100: 100' Power Cord for GVC-18000 **\$1,400.00**

PUREBELT® MODULAR SYSTEM - CONVEYOR BELT CLEANING SYSTEM FOR INTRALOX MESH AND METAL WIRE BELTS



PUREBELT® MODULAR SYSTEM: Is a robotic automated conveyor belt cleaning system. For mesh belts. Standard version is 45", wider versions available..... **Call for Price**



GVC-SH-25-10-ASSM: 10' Steam Hose with 1/4" Inside Diameter
Connects Dry Steam Cleaner to Belt Cleaning System **\$1,595.00**

GVC-SH-25-20-ASSM: 20' Steam Hose with 1/4" Inside Diameter
Connects Dry Steam Cleaner to Belt Cleaning System **\$2,395.00**

GVC-SH-25-30-ASSM: 30' Steam Hose with 1/4" Inside Diameter
Connects Dry Steam Cleaner to Belt Cleaning System **\$3,695.00**

GVC-SH-38-10-ASSM: 10' Steam Hose with 3/8" Inside Diameter
Connects Dry Steam Cleaner to Belt Cleaning System **\$1,595.00**

GVC-SH-38-20-ASSM: 20' Steam Hose with 3/8" Inside Diameter
Connects Dry Steam Cleaner to Belt Cleaning System **\$2,395.00**

GVC-SH-38-30-ASSM: 30' Steam Hose with 3/8" Inside Diameter
Connects Dry Steam Cleaner to Belt Cleaning System **\$3,695.00**



93-KIT5003/8: Adapter connects GVC to 93-ACC-SH..... **\$395.00**

93-KIT5003/8-NEW: Adapter connects GVC to 93-ACC-SH,
large diameter..... **\$395.00**



93-KIT5003/8RC2: Remote control adapter, Belt Cleaner to GVC-18000, 1/4 x 8MM + 12V Connectors M+F..... **Call for Price**

93-KIT5003/8RC1: Remote control adapter, Belt Cleaner to GVC-36000, 3/8 x 8MM + 12V Connectors M+F..... **Call for Price**



GVC-MODULAR-PWRCORD: 3 meter power cord for GVC-MODULAR..... **\$305.00**

PORTABLE BRUSHLESS/BRUSH SYSTEMS: CONVEYOR BELT CLEANING SYSTEM FOR FLAT, SOLID (WEB) BELTS



PUREBELT® PORTABLE BRUSHLESS BELT CLEANING SYSTEM: for Flat Belt Systems with dry steam and vacuum. Completely portable.. **Call for Price**

PUREBELT® PORTABLE BRUSH SYSTEM: CIP System for Flat, Solid Belts with dry steam and vacuum. Completely portable and will fit a range of belt widths up to 10" with an additional motorized food grade brush **Call for Price**



GVC-SH-25-10-ASSM: 10' Steam Hose with 1/4" Inside Diameter Connects Dry Steam Cleaner to Belt Cleaning System **\$1,595.00**

GVC-SH-25-20-ASSM: 20' Steam Hose with 1/4" Inside Diameter Connects Dry Steam Cleaner to Belt Cleaning System **\$2,395.00**

GVC-SH-25-30-ASSM: 30' Steam Hose with 1/4" Inside Diameter Connects Dry Steam Cleaner to Belt Cleaning System **\$3,695.00**

GVC-SH-38-10-ASSM: 10' Steam Hose with 3/8" Inside Diameter Connects Dry Steam Cleaner to Belt Cleaning System **\$1,595.00**

GVC-SH-38-20-ASSM: 20' Steam Hose with 3/8" Inside Diameter Connects Dry Steam Cleaner to Belt Cleaning System **\$2,395.00**

GVC-SH-38-30-ASSM: 30' Steam Hose with 3/8" Inside Diameter Connects Dry Steam Cleaner to Belt Cleaning System **\$3,695.00**



93-KIT5003/8: Adapter connects GVC to 93-ACC-SH **\$395.00**

93-KIT5003/8-NEW: Adapter connects GVC to 93-ACC-SH, large diameter **\$395.00**



VAC-32-BRUSHLESS Smooth bore PVC Hose for Belt Cleaning **Call for Price**

FIXED BRUSH/BRUSHLESS SYSTEM: CONVEYOR BELT CLEANING SYSTEM FOR FLAT, SOLID (WEB) BELTS



PUREBELT® FIXED BRUSHLESS BELT CLEANING SYSTEM:

Permanent clean-in place of flat belts. Contentiously clean even during production. **Call for Price**



93-KIT5003/8: Adapter connects GVC to 93-ACC-SH..... **\$395.00**

93-KIT5003/8-NEW: Adapter connects GVC to 93-ACC-SH, large diameter..... **\$395.00**



GVC-SH-25-10-ASSM: 10' Steam Hose with 1/4" Inside Diameter
Connects Dry Steam Cleaner to Belt Cleaning System **\$1,595.00**

GVC-SH-25-20-ASSM: 20' Steam Hose with 1/4" Inside Diameter
Connects Dry Steam Cleaner to Belt Cleaning System **\$2,395.00**

GVC-SH-25-30-ASSM: 30' Steam Hose with 1/4" Inside Diameter
Connects Dry Steam Cleaner to Belt Cleaning System **\$3,695.00**

GVC-SH-38-10-ASSM: 10' Steam Hose with 3/8" Inside Diameter
Connects Dry Steam Cleaner to Belt Cleaning System **\$1,595.00**

GVC-SH-38-20-ASSM: 20' Steam Hose with 3/8" Inside Diameter
Connects Dry Steam Cleaner to Belt Cleaning System **\$2,395.00**

GVC-SH-38-30-ASSM: 30' Steam Hose with 3/8" Inside Diameter
Connects Dry Steam Cleaner to Belt Cleaning System **\$3,695.00**



93-KIT5003/8RC2: Remote control adapter, Belt Cleaner to GVC-18000, 1/4 x 8MM + 12V Connectors M+F..... **Call for Price**

93-KIT5003/8RC1: Remote control adapter, Belt Cleaner to GVC-36000, 3/8 x 8MM + 12V Connectors M+F..... **Call for Price**



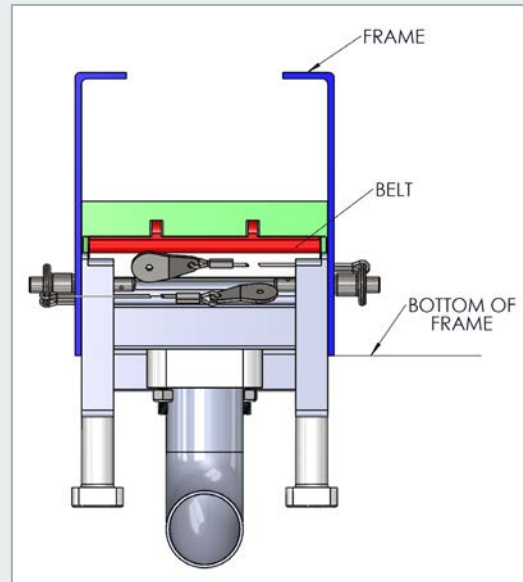

PUREBELT® BOTTLING LINE BELT CLEANING SYSTEM: Belt cleaning system cleans bottling line belts in place automatically with dry steam and vacuum extraction..... **Call for Price**

NARROW WIDTH SUSPENDED BRUSHLESS: For brushless applications with high guide rails, or that need to be suspended in a unique way, we can customize to fit your specific application..... **Call for Price**

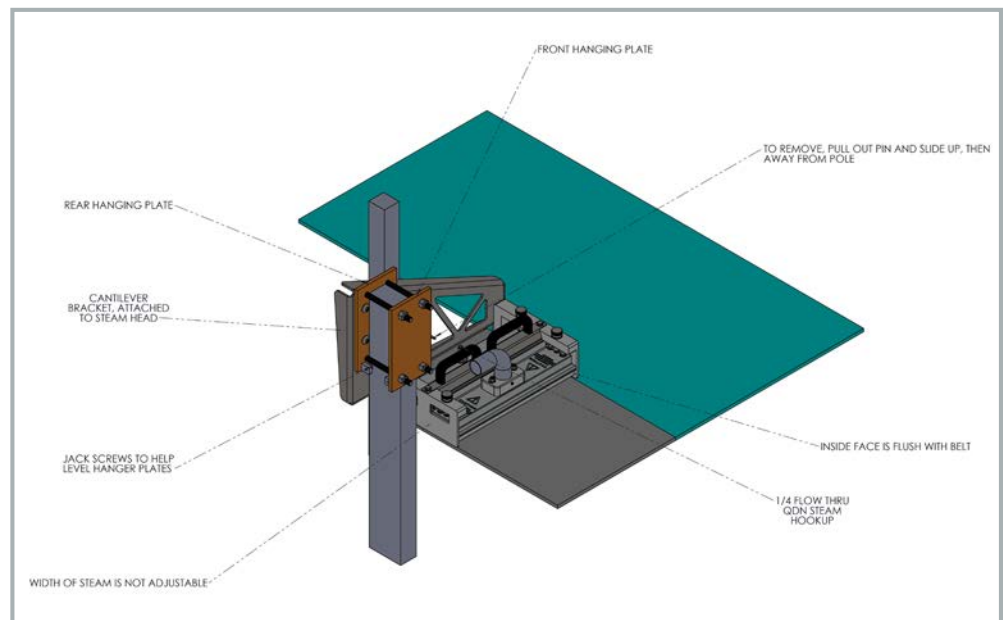
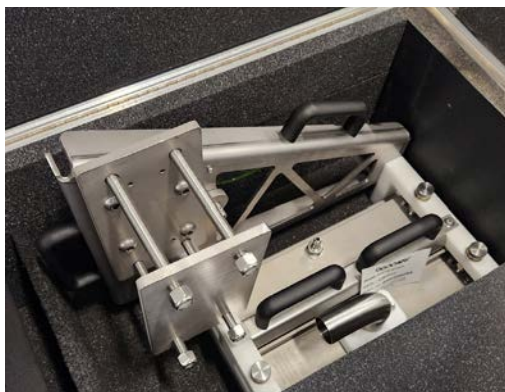

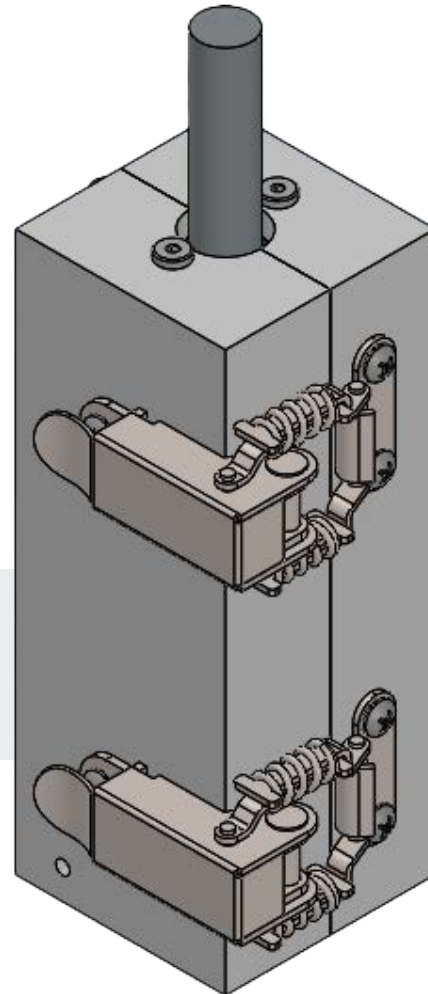

NOZZLE SANITIZING SYSTEM: designed to sanitize filler nozzles and water cutting nozzles from the bottom up by applying steam to sanitize microorganisms **Call for Price**

CONTINUED CUSTOM AUTOMATED CLEANING SOLUTIONS

BUN PAN CLEANING SYSTEM:

Customizable Pan Width - Designed for Glaze / Egg Wash Removal..... **Call for Price**

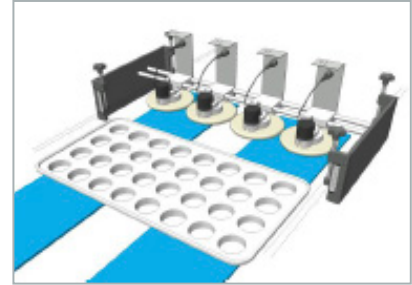

SMALL WIDTH INTRALOX CONVEYOR BELT CLEANER:

Small Belt Cleaner with Motorized Spinner Nozzles..... **Call for Price**

PORTABLE BRUSHLESS SYSTEM WITHOUT STIFFENER PLATE:

Portable Brushless without the standard stiffener plate. For quicker setup & tight spaces..... **Call for Price**

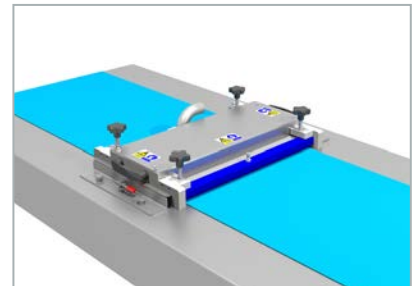
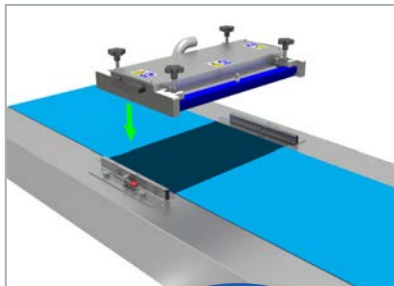

GVC-CART-XXX: Our belt cleaner carts offer secure storage for both our PureBelt® Modular & Portable. The carts feature robust stainless steel construction that is built to last, swivel castors for easy mobility and multiple hooks for storing hoses and accessories. Some models also feature a squeegee replacement station.... **Call for Price**